



EHL
PROLIST

Sortimentslista

order@prolist.se
0224-660 550
www.ehlprolist.se

Avvikande dimensioner

Har ni behov av andra dimensioner än de som finns i vårt sortiment har vi möjlighet att ta fram dessa.

Exaktkapningar

Vet ni att era kunder behöver exakta mått kan vi ombesörja det och underlätta för er.

Kundspecifika kulörer

Vi har möjlighet att ta fram listverk med andra kulörer om så önskas.

Kundspecifika profiler (verktyg)

Vi kan ta fram verktyg till specifika profiler.

Andra träslag

Vi kan även erbjuda fler träslag än de som finns i sortimentslistan, kontakta oss för offert.

Rengöring – använd ett mildt rengöringsmedel och en lätt fuktad trasa.

Övermålningsbar – rugga upp ytan som är vaxliknande. Detta gör att ny färg får lättare att fästa. Applicera därefter ny färg. Alternativt välj våra grundmålade lister.

Furu obh	obehandlad furu	typ A
Furu B	obehandlad furu	typ B
Furu vit	Ncs S 0502-Y	glans 25-30
Furu vit	Ncs S 0500-N	glans 25-30
MDF vit	Ncs S 0502-Y	glans 25-30
Lackad ek	Klarlack	glans 25-30
Furu grundmålad – grundmålad vit för enklare övermålning efter lätt slipning.		

Om du inte hittar vad du söker tar vi gärna fram andra alternativ vad gäller kulörer, dimensioner, träslag och profiler!

EHL Prolist AB ingår i samma koncern som:



Prolist Nordic AB,
Produktionsanläggning

Våra vitmålade furu- och MDF-lister är
bedömda i SundaHus Miljödata



Intertek



För certifieringar och kvalitetsdokument – se vår hemsida www.ehlprolist.se

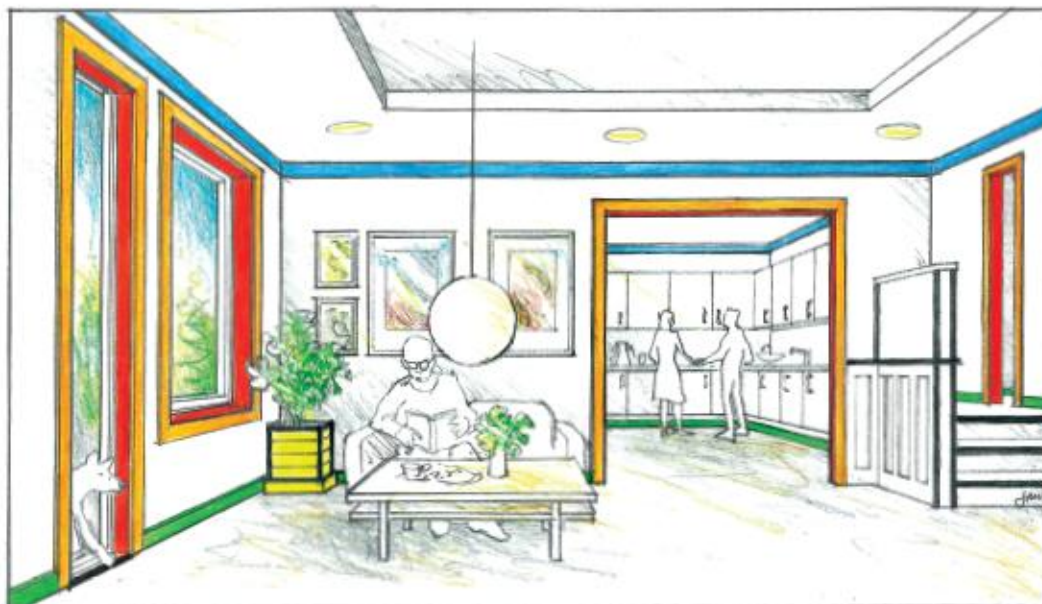

HITTA RÄTT LIST

Följ färgkodningen för att hitta den list ni söker

FODER

Foder används runt fönster och dörrar för att täcka skarven mellan karm och vägg.

SOCKEL

Sockel används för att täcka springor mellan golv och vägg.

TAKLIST

Taklist används i övergången mellan tak och vägg för att täcka springor.

ÖVRIGA LISTER

Övriga lister används primärt för att täcka springor och skarvar, till exempel Foglist, Smyglist, Kvartstav, Rundstav mm.

FÖNSTERMYG/DÖRRROMFATTNING

Fönstersmyg används vid montering av fönster och dörrar som utsalning mot vägg. Dörrromfattning används där det saknas karm i dörrhål och valv.

PLANHYVLAT

Planhyvlat har många användningsområden. Planhyvlat används ofta vid utsalning av fönster och dörrar och till allmänna snickerier.







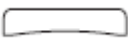

Innehåll





Foder slät.....	1
Klackfoder.....	2
Foder, profilerade.....	2
Sockel	3
Sockel, profilerade.....	4
Taklister	5
Bröstlister	6
Hörnlister.....	6
Flexilist MDF	6
Salningslister	6
Smyglister	7
Foglister/Täckbräda.....	7
Rundstav.....	8
Kvartstav.....	8
Trekantslist	9
Kakellist	9
Glaslist	9
Falsad fönstersmyg Furu	9
Spårad fönstersmyg MDF	10
Falsad fönstersmyg MDF	10
Dörromfattning MDF	11
U-list	11
SimSALabim-listen.....	11
Clips/ Bättringsfärg.....	11
Planhyvlat	12
Kortlister	13
Lister MDF	14
Bastuartiklar	15
Halvstav	15
Lustejp	15
Dekorlist	15
Klossar	15
Diverse.....	16
Övrigt.....	16
Monteringsanvisning.....	17
Produktinformation Vitmålad Furu	18
Produktinformation MDF	19

Foder slät	Dimension mm	Beskrivning	Enhet/bunt	Enhet
	200144	10x43x4400	Foder vit	10 st
	200344	10x56x4400	Foder vit	10 st
	200311	10x56x1100	Foder vit	5 st
	300344	10x56x4400	Foder vit 0500-N	10 st
	200444	10x69x4400	Foder vit	10 st
	200644	12x43x4400	Foder vit	10 st
	2006	12x43x2200	Foder vit	10 st
	300544	12x43x4400	Foder vit 0500-N	10 st
	200722	12x43x2200	Foder vit 0500-N	10 st
	5005	12x43	Foder obh	28 lpm
	5006	12x43x2200	Foder obh	10 st
	9202	12x43	Foder grundmålad	44 lpm
	4005	12x44	Foder Ek lackad	52 lpm
	201044	12x56x4400	Foder vit	10 st
	2010	12x56x2200	Foder vit	10 st
	201027	12x56x2700	Foder vit	10 st
	201036	12x56x3600	Foder vit	10 st
	301144	12x56x4400	Foder vit 0500-N	10 st
	201122	12x56x2200	Foder vit 0500-N	10 st
	201127	12x56x2700	Foder vit 0500-N	10 st
	5008	12x56	Foder obh	28 lpm
	5010	12x56x2200	Foder obh	10 st
	9008	12x56	Foder grundmålad	44 lpm
	9010	12x56x2200	Foder grundmålad	10 st
	6008	12x56	Foder Eklasyr	28 lpm
	4008	12x56	Foder Ek lackad	35 lpm
	4010	12x56x2200	Foder Ek lackad	10 st
	401011	12x56x1100	Foder Ek lackad	5 st
	7508	12x58x4000	Foder Ekfanerad lackad	10 st
	7510	12x58x2200	Foder Ekfanerad lackad	10 st
	4930	12x56	Foder Björk lackad	35 lpm
	493022	12x56x2200	Foder Björk lackad	10 st
	4950	12x56mm	Foder Bok lackad	35 lpm
	495022	12x56x2200	Foder Bok lackad	10 st
	2009	12x56x2200+1100	Foderset vit	1 st
	200900	12x56x2200+1100	Foderset vit 0500-N	1 st
	5009	12x56x2200+1100	Foderset obh	1 st
	201444	12x69x4400	Foder vit	10 st
	2014	12x69x2200	Foder vit	10 st
	301944	12x69x4400	Foder vit 0500-N	10 st
	201922	12x69x2200	Foder vit 0500-N	10 st
	5013	12x69	Foder obh	28 lpm
	5014	12x69x2200	Foder obh	10 st
	9013	12x69	Foder grundmålad	44 lpm
	4013	12x69	Foder Ek lackad	28 lpm
	2012	12x69x2200+1100	Foderset vit	1 st
	201644	12x95x4400	Foder vit	10 st
	301544	12x95x4400	Foder vit 0500-N	10 st
	2016	12x95x2200	Foder vit	10 st
	201600	12x95x2200	Foder vit 0500-N	10 lpm
	5015	12x95	Foder obh	28 lpm
	5016	12x95x2200	Foder obh	10 st
	9017	15x33	Foder grundmålad	44 lpm
	201744	15x56x4400	Foder vit	8 st
	2018	15x56x2200	Foder vit	10 st
	302044	15x56x4400	Foder vit 0500-N	8 st







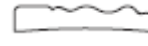

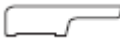

Foder slät, forts.	Dimension mm	Beskrivning	Enhet/bunt	Enhet
 202222	15x56x2200	Foder vit 0500-N	10	st
202044	15x69x4400	Foder vit	8	st
2021	15x69x2200	Foder vit	10	st





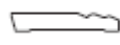



Klackfoder	Dimension mm	Beskrivning	Enhet/bunt	Enhet
 204044	15x56x4400	Klackfoder vit	10	st
204144	21x43x4400	Klackfoder vit	10	st
5041	21x43	Klackfoder obh	28	lpm
204244	21x56x4400	Klackfoder vit	10	st
5042	21x56	Klackfoder obh	28	lpm
2043	21x56x2200	Klackfoder vit	8	st
304244	21x56x4400	Klackfoder vit 0500-N	10	st
5043	21x56x2200	Klackfoder obh	10	st





Foder, profilerade	Dimension mm	Beskrivning	Enhet/bunt	Enhet
 5020	15x56	Foder Furu obh/Skrea	28	lpm
 202444	15x69x4400	Allmogefoder vit (286)	8	st
302444	15x69x4400	Allmogefoder 0500-N (286)	8	st
5023	15x69	Allmogefoder obh (286)	28	lpm
5323	15x69	Allmogefoder obh B (286)	18	lpm
2024	15x69x2200	Allmogefoder vit (286)	10	st
5024	15x69x2200	Allmogefoder obh (286)	10	st
202644	15x95x4400	Allmogefoder vit (287)	8	st
302644	15x95x4400	Allmogefoder 0500-N (287)	8	st
5025	15x95	Allmogefoder obh (287)	28	lpm
2026	15x95x2200	Allmogefoder vit (287)	5	st
5026	15x95x2200	Allmogefoder obh (287)	5	st
5028	15x95	Allmogefoder obh B (287)	18	lpm
5029	21x120	Allmogefoder obh (287)	18	lpm
 203144	15x69x4400	Allmogefoder vit (289)	8	st
5031	15x69	Allmogefoder obh (289)	18	lpm
903844	21x95x4400	Allmogefoder grundmålad 343	5	st
 202744	15x69x4400	Allmogefoder vit (290)	8	st
5027	15x69	Allmogefoder obh (290)	18	lpm
 203344	15x69x4400	Allmogefoder vit (291)	8	st
5033	15x69	Allmogefoder obh (291)	18	lpm
203444	15x95x4400	Allmogefoder vit (296)	8	st
5034	15x95	Allmogefoder obh (296)	18	lpm
 202944	21x69x4400	Allmogefoder vit (298)	8	st
 203044	21x95x4400	Allmogefoder vit (307)	5	st
5030	21x95	Allmogefoder obh (307)	15	lpm
 203544	15x69x4400	Allmogefoder vit (295)	8	st
5035	15x69	Allmogefoder obh (295)	18	lpm
203644	15x95x4400	Allmogefoder vit (239)	8	st
5036	15x95	Allmogefoder obh (239)	18	lpm

Foder profilerade forts	Dimension mm	Beskrivning	Enhet/bunt	Enhet
 206044	21x95x4400	Allmogefoder West vit	5	st
5060	21x95	Allmogefoder West obh	18	lpm
5061	21x120	Allmogefoder West obh	18	lpm
5160	21x95	Allmogefoder West gran	18	lpm
5161	21x120	Allmogefoder West gran	18	lpm
 206244	15x69x4400	Allmogefoder Syd vit	8	st
206222	15x69x2200	Allmogefoder Syd vit	10	st
5062	15x69	Allmogefoder Syd obh	18	lpm
506222	15x69x2200	Allmogefoder Syd obh	10	st
 206344	15x95x4400	Allmogefoder Syd vit	8	st
206322	15x95x2200	Allmogefoder Syd vit	10	st
5063	15x95	Allmogefoder Syd obh	18	lpm
506322	15x95x2200	Allmogefoder Syd obh	10	st
 5038	21x95	Allmogefoder obh 343	18	lpm
 2223	13x69	Antikfoder furu vit	35,2	lpm
2224	15x95	Antikfoder furu vit	22	lpm

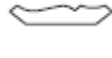
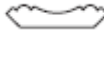
Sockel	Dimension mm	Beskrivning	Enhet/bunt	Enhet
 220244	12x43x4400	Sockel vit	10	st
320244	12x43x4400	Sockel vit 0500-N	10	st
5202	12x43	Sockel obh	28	lpm
9201	12x43	Sockel grundmålad	44	lpm
4202	12x44	Sockel Ek lackad	42	lpm
220444	12x56x4400	Sockel vit	10	st
2204300	12x56x3000	Sockel vit	10	st
2204360	12x56x3600	Sockel vit	10	st
320344	12x56x4400	Sockel vit 0500-N	10	st
320330	12x56x3000	Sockel vit 0500-N	10	st
5204	12x56	Sockel obh	28	lpm
9204	12x56	Sockel grundmålad	35	lpm
6204	12x56	Sockel Ek lasyr	28	lpm
4204	12x56	Sockel Ek lackad	42	lpm
7704	12x58x4000	Sockel Ekfanerad lackad	10	st
4931	12x56	Sockel Björk lackad	35	lpm
4951	12x56	Sockel Bok lackad	35	lpm
220544	12x69x4400	Sockel vit	10	st
220536	12x69x3600	Sockel vit	10	st
320744	12x69x4400	Sockel vit 0500-N	10	st
5205	12x69	Sockel obh	28	lpm
9205	12x69	Sockel grundmålad	35	lpm
6205	12x69	Sockel Ek lasyr	28	lpm
4205	12x69	Sockel Ek lackad	35	lpm
7705	12x70x4000	Sockel Ekfanerad lackad	10	st
220644	12x95x4400	Sockel vit	10	st
320644	12x95x4400	Sockel vit 0500-N	10	st
5206	12x95	Sockel obh	18	lpm
220844	15x56x4400	Sockel furu vit	8	st
320944	15x56x4400	Sockel furu vit 0500-N	8	st
220944	15x69x4400	Sockel furu vit	8	st



Socket, profilerade	Dimension mm	Beskrivning	Enhet/bunt	Enhet
	230744	14x56x4400	Ventilerad sockel vit	8 st
	5307	14x56	Ventilerad sockel obh	25 lpm
	221044	15x56x4400	Socket kabelsp. Vit	8 st
	7708	16x60x4000	Socket kabelsp. Ekfanér lack	10 st
	5209	15x69	Socket furu obh/Skrea	28 lpm
	5210	15x95	Socket furu obh/Skrea	28 lpm
	221144	15x69x4400	Allmogesocket vit (308)	8 st
	221136	15x69x3600	Allmogesocket vit (308)	8 st
	321144	15x69x4400	Allmogesocket 0500-N (308)	8 st
	5211	15x69	Allmogesocket obh (308)	18 lpm
	5311	15x69	Allmogesocket obh B (308)	18 lpm
	221244	15x95x4400	Allmogesocket vit (310)	8 st
	321244	15x95x4400	Allmogesocket 0500-N (310)	8 st
	5212	15x95	Allmogesocket obh (310)	18 lpm
	5213	15x95	Allmogesocket obh B (310)	18 lpm
	221544	21x120x4400	Allmogesocket vit (312)	5 st
	5215	21x120	Allmogesocket obh B (312)	18 lpm
		223144	15x69x4400	Allmogesocket vit (330)
5231		15x69	Allmogesocket obh (330)	18 lpm
5232		15x95	Allmogesocket obh (331)	18 lpm
	223544	15x69x4400	Allmogesocket vit (338)	8 st
	5235	15x69	Allmogesocket obh (338)	18 lpm
	223644	15x95x4400	Allmogesocket vit (339)	8 st
5236	15x95	Allmogesocket obh (339)	18 lpm	
	223344	15x69x4400	Allmogesocket vit (337)	8 st
	5233	15x69	Allmogesocket obh (337)	18 lpm
	223444	15x95x4400	Allmogesocket vit (332)	8 st
	5234	15x95	Allmogesocket obh (332)	18 lpm
	923844	21x95x4400	Allmogesocket Grundm.343	5 st
	5216	21x120	Allmogesocket obh B (343)	18 lpm
	5218	21x120	Allmogesocket obh (343)	18 lpm
	921844	21x120x4400	Allmogesocket Grundm. 343	5 st
	5217	21x145	Allmogesocket obh B (346)	18 lpm
	5260	21x95	Allmogesocket West obh	18 lpm
	226144	21x120x4400	Allmogesocket West vit	5 st
	5261	21x120	Allmogesocket West obh	18 lpm
	226244	15x69x4400	Allmogesocket Syd vit	8 st
	5262	15x69	Allmogesocket Syd obh	18 lpm
	226344	15x95x4400	Allmogesocket Syd vit	8 st
	5263	15x95	Allmogesocket Syd obh	18 lpm
	2213	13x69	Antiksocket Furu vit	35 lpm
	5312	15x69	Antiksocket Furu B	18 lpm
	5313	15x95	Antiksocket Furu B	18 lpm
	2214	15x95	Antiksocket Furu vit	22 lpm
	2216	21x120	Antiksocket Furu vit	22 lpm

	Taklister	Dimension mm	Beskrivning	Enhet/bunt	Enhet	
	5621	12x27	Hålkäl obh	36	lpm	
	262144	12x27x4400	Hålkäl vit	10	st	
	261044	15x33x4400	Hålkäl vit	10	st	
	5610	15x33	Hålkäl obh	35	lpm	
	261136	15x43x3600	Hålkäl vit	10	st	
	261144	15x43x4400	Hålkäl vit	10	st	
	361144	15x43x4400	Hålkäl vit 0500-N	10	st	
	5611	15x43	Hålkäl obh	35	lpm	
	9611	15x43	Hålkärl grundmålad	35	lpm	
	261244	15x56x4400	Hålkäl vit	10	st	
	361244	15x56x4400	Hålkäl vit 0500-N	10	st	
	261236	15x56x3600	Hålkäl vit	10	st	
	5612	15x56	Hålkäl obh	35	lpm	
	9612	15x56	Hålkäl grundmålad	35	lpm	
	261344	20x69x4400	Hålkäl vit	10	st	
	5613	20x69	Hålkäl obh	35	lpm	
	5615	21x95	Hålkäl obh	18	lpm	
		261444	15x43x4400	Bråttlist vit 135°	10	st
		263144	21x33x4400	Enkelskugga vit	10	st
		263136	21x33x3600	Enkelskugga vit	10	st
363044		21x33x4400	Enkelskugga 0500-N	10	st	
9631		21x33x4400	Enkelskugga Grundmålad	44	lpm	
5631		21x33	Enkelskugga obh	35	lpm	
	263244	21x43x4400	Dubbelskugga vit	10	st	
	263236	21x43x3600	Dubbelskugga vit	10	st	
	363444	21x43x4400	Dubbelskugga 0500-N	10	st	
	5632	21x43	Dubbelskugga obh	35	lpm	
	263344	33x43x4400	Skugglist vit	10	st	
	5633	33x43	Skugglist obh	35	lpm	
	5305	21x43	Trapplist obeh 354	20	lpm	
	260244	15x43x4400	Taklist vit Svanhals	10	st	
	5602	15x43	Taklist obh Svanhals	35	lpm	
	260344	15x56x4400	Taklist vit Svanhals	10	st	
	260336	15x56x3600	Taklist vit Svanhals	10	st	
	5603	15x56	Taklist obh Svanhals	35	lpm	
	9603	15x56	Taklist grund Svanhals	44	lpm	
	260444	15x69x4400	Taklist vit Svanhals	8	st	
	5604	15x69	Taklist obh Svanhals	18	lpm	
	260544	21x69x4400	Allmogetaklist vit (362)	5	st	
	5605	21x69	Allmogetaklist obh (362)	18	lpm	
	260944	15x43x4400	Bråttlist allmoge vit (411)	10	st	
	230444	15x69x4400	Allmogetaklist vit (363)	8	st	
	5304	15x69	Allmogetaklist obh (363)	18	lpm	
	5303	15x69	Allmogetaklist obh B (363)	18	lpm	
	5606	21x95	Allmogetaklist obh (381)	18	lpm	
	260844	15x69x4400	Hålkäl allmoge vit (369)	8	st	
	5608	15x69	Hålkäl allmoge obh (369)	18	lpm	

	Bröstlister	Dimension mm	Beskrivning	Enhet/bunt	Enhet
	250544	21x45x4400	Bröstlist vit fals 12 mm	10	st
	5505	21x45	Bröstlist obh fals 12 mm	35	lpm
	2506	21x43x2400	Bröstlist vit 390 m fals 6mm	10	st
	5506	21x43	Bröstlist obh 390	35	lpm
	5507	33x43	Bröstlist obh 392	35	lpm
	5508	21x33	Bröstlist obh 395 fals 12mm	35	lpm
	251036	27x43x3600	Bröstlist vit	10	st

	Hörnlistor	Dimension mm	Beskrivning	Enhet/bunt	Enhet
	243100	21x21x2700	Hörnlist vit 0500-N	10	st
	2431	21x21x2700	Hörnlist vit	10	st
	5431	21x21x2700	Hörnlist obh	10	st
	443127	21x21x2700	Hörnlist Ek lackad	10	st
	2433	27x27x2700	Hörnlist vit	10	st
	5433	27x27x2700	Hörnlist obh	10	st
	443327	27x27x2700	Hörnlist Ek lackad	10	st
	2435	33x33x2700	Hörnlist vit	10	st
	243500	33x33x2700	Hörnlist vit 0500-N	10	st
	5435	33x33x2700	Hörnlist obh	10	st
	2437	43x43x2700	Hörnlist vit	10	st
	5437	43x43x2700	Hörnlist obh	10	st

	Flexilist MDF	Dimension mm	Beskrivning	Enhet/bunt	Enhet
	1661	25x25x2700	Flexilist vit MDF - folierad	20	st
	166100	25x25x2700	Flexilist 0500 MDF - folierad	20	st
	1662	35x35x2700	Flexilist vit MDF - folierad	20	st

	Salningslister	Dimension mm	Beskrivning	Enhet/bunt	Enhet
	242022	19x27x2200	Salningslist vit	10	st
	241922	19x27x2200	Salningslist vit 0500-N	10	st
	242030	19x27x3000	Salningslist vit	10	st
	242044	19x27x4400	Salningslist vit	10	st
	24204400	19x27x4400	Salningslist vit 0500-N	10	st
	240844	21x33x4400	Salningslist vit	6	st
	2421	21x43x2200	Salningslist vit	6	st
	242244	21x43x4400	Salningslist vit	6	st
	342244	21x43x4400	Salningslist vit 0500-N	6	st
	2423	21x69x2200	Salningslist vit	6	st
	242444	21x69x4400	Salningslist vit	6	st
	342444	21x69x4400	Salningslist vit 0500-N	6	st
	242544	21x95x4400	Salningslist vit	6	st
	2426	21x95x2200	Salningslist vit	6	st

	Smyglister	Dimension mm	Beskrivning	Enhet/bunt	Enhet
	241044	8x15x4400	Smyglist vit	15	St
	5410	8x15	Smyglist vit	54	lpm
	241024	8x15x2400	Smyglist vit	15	st
	541024	8x15x2400	Smyglist obh	15	st
	4410	8x15	Smyglist Ek lackad	50	lpm
	441012	8x15x1200	Smyglist Ek lackad	35	st
	241144	8x21x4400	Smyglist vit	15	st
	341144	8x21x4400	Smyglist vit 0500-N	15	st
	5411	8x21	Smyglist obh	54	lpm
	241124	8x21x2400	Smyglist vit	15	st
	541124	8x21x2400	Smyglist obh	15	st
	4411	8x21	Smyglist Ek lackad	50	lpm
	4936	8x21	Smyglist Björk lackad	50	lpm
	241244	8x27x4400	Smyglist vit	15	st
	341244	8x27x4400	Smyglist vit 0500-N	15	st
	5412	8x27	Smyglist obh	54	lpm
	241224	8x27x2400	Smyglist vit	15	st
	541224	8x27x2400	Smyglist obh	15	st
	4412	8x27	Smyglist Ek lackad	50	lpm
	441212	8x27x1200	Smyglist Ek lackad	35	st
	241344	8x33x4400	Smyglist vit	15	st
	341344	8x33x4400	Smyglist vit 0500-N	15	st
	5413	8x33	Smyglist obh	54	lpm
	241324	8x33x2400	Smyglist vit	15	st
	541324	8x33x2400	Smyglist obh	15	st
	4413	8x33	Smyglist Ek lackad	50	lpm
	241444	8x43x4400	Smyglist vit	15	st
	5414	8x43	Smyglist obh	54	lpm
	241424	8x43x2400	Smyglist vit	15	st
	541424	8x43x2400	Smyglist obh	15	st
	4414	8x44	Smyglist Ek lackad	50	lpm
	2415	13x21x2200	Smyglist vit, rak bakkant	20	st
	241744	15x21x4400	Smyglist vit	10	st
	241844	15x27x4400	Smyglist vit	10	st
	241644	15x33x4400	Smyglist vit	10	st
	5416	15x33	Smyglist obh	35	lpm
9416	15x33	Smyglist grundmålad	44	lpm	

	Foglisters/Täckbräda	Dimension mm	Beskrivning	Enhet/bunt	Enhet
	5400	6x21	Foglist obh	66	lpm
	240024	8x15x2400	Foglist vit	15	st
	540024	8x15x2400	Foglist obh	15	st
	240144	8x21x4400	Foglist vit	15	st
	5401	8x21	Foglist obh	54	lpm
	240124	8x21x2400	Foglist vit	15	st
	340144	8x21x4400	Foglist vit 0500-N	15	st
	540124	8x21x2400	Foglist obh	15	st
	4401	8x21	Foglist Ek lackad	50	lpm
	240244	8x27x4400	Foglist vit	15	st
	340244	8x27x4400	Foglist vit 0500-N	15	st
	5402	8x27	Foglist obh	54	lpm
	240224	8x27x2400	Foglist vit	15	st
	540224	8x27x2400	Foglist obh	15	st
	4402	8x27	Foglist Ek lackad	50	lpm
	240344	8x33x4400	Foglist vit	15	st

Fog/Täckbräda, forts.	Dimension mm	Beskrivning	Enhet/bunt	Enhet
	340344	8x33x4400	Foglist vit 0500-N	15 st
	5403	8x33	Foglist obh	54 lpm
	240324	8x33x2400	Foglist vit	15 st
	540324	8x33x2400	Foglist obh	15 st
	4403	8x33	Foglist Ek lackad	50 lpm
	240444	8x43x4400	Foglist vit	15 st
	340444	8x43x4400	Foglist vit 0500-N	15 st
	5404	8x43	Foglist obh	54 lpm
	240424	8x43x2400	Foglist vit	15 st
	540424	8x43x2400	Foglist obh	15 st
	4404	8x44	Foglist Ek lackad	50 lpm
	4405	8x95	Foglist Ek lackad	30 lpm
	240944	21x27x4400	Foglist vit	10 st
	242944	21x69x4400	Täckbräda vit	6 st
	242922	21x69x2200	Täckbräda vit	6 st
	2430440	21x95x4400	Täckbräda vit	6 st
	2430	21x95x2200	Täckbräda vit	6 st
	242744	21x120x4400	Täckbräda vit	3 st
	242722	21x120x2200	Täckbräda vit	6 st
	242844	21x145x4400	Täckbräda vit	3 st
242822	21x145x2200	Täckbräda vit	6 st	

Rundstav	Dimension mm	Beskrivning	Enhet/bunt	Enhet
	5461	8	Rundstav obeh	72 lpm
	546125	8x2500	Rundstav obeh	20 st
	5462	10	Rundstav obeh	72 lpm
	546225	10x2500	Rundstav obeh	20 st
	5463	12	Rundstav obeh	72 lpm
	546325	12x2500	Rundstav obeh	20 st
	5464	15	Rundstav obeh	72 lpm
	546425	15x2500	Rundstav obeh	20 st
	5465	21	Rundstav obeh	54 lpm
	546525	21x2500	Rundstav obeh	20 st
	5466	25	Rundstav obeh	54 lpm
	546625	25x2500	Rundstav obeh	15 st
	5467	27	Rundstav obeh	54 lpm
	546725	27x2500	Rundstav obeh	15 st
	5468	33	Rundstav obeh	35 lpm
	546825	33x2500	Rundstav obeh	10 st
	5469	43	Rundstav obeh	35 lpm
	546925	43x2500	Rundstav obeh	10 st

Kvartstav	Dimension mm	Beskrivning	Enhet/bunt	Enhet
	244124	9x9x2400	Kvartstav vit	20 st
	544124	9x9x2400	Kvartstav obh	20 st
	4441	9x9	Kvartstav Ek lackad	50 lpm
	244244	12x12x4400	Kvartstav vit	20 st
	344244	12x12x4400	Kvartstav vit 0500-N	20 st
	5442	12x12	Kvartstav obeh	70 lpm
	244224	12x12x2400	Kvartstav vit	20 st
	544224	12x12x2400	Kvartstav obh	20 st
	6442	12x12	Kvartstav Ek lasyr	70 lpm

Kvartstav, fort.	Dimension mm	Beskrivning	Enhet/bunt	Enhet
	4442	12x12	Kvartstav Ek lackad	50 lpm
	444212	12x12x1200	Kvartstav Ek lackad	35 st
	444224	12x12x2400	Kvartstav Ek lackad	20 st
	244344	15x15x4400	Kvartstav vit	20 st
	5443	15x15	Kvartstav obeh	70 lpm
	244324	15x15x2400	Kvartstav vit	20 st
	24432400	15x15x2400	Kvartstav vit 0500-N	20 st
	544324	15x15x2400	Kvartstav obh	20 st
	4443	15x15	Kvartstav Ek lackad	50 lpm
	444312	15x15x1200	Kvartstav Ek lackad	20 st
	444324	15x15x2400	Kvartstav Ek lackad	20 st
	244444	21x21x4400	Kvartstav vit	20 st
	5444	21x21	Kvartstav obeh	54 lpm
	244424	21x21x2400	Kvartstav vit	20 st
	544424	21x21x2400	Kvartstav obh	20 st
	4444	21x21	Kvartstav Ek lackad	50 lpm
	544524	27x27x2400	Kvartstav obeh	20 st

Trekantslist	Dimension mm	Beskrivning	Enhet/bunt	Enhet
	5449	15	Trekant Furu A	150 lpm
	5450	21	Trekant Furu A	150 lpm
	213GSF	21	Trekant Gran	60 lpm

Kakellist	Dimension mm	Beskrivning	Enhet/bunt	Enhet
	246044	15x57x4400	Kakellist vit	10 st

Glaslist	Dimension mm	Beskrivning	Enhet/bunt	Enhet
	248044	11x23x4400	Glaslist Furu vit 424	10 st
	5481	15x21	Glaslist Obh	36 lpm

Falsad fönstersmyg Furu	Dimension mm	Beskrivning	Enhet/bunt	Enhet
	2107	18x70x4400	Furusmyg fals vit -9,5x35	1 st
	2108	18x95x2400	Furusmyg fals vit -9,5x35	1 st
	2109	18x95x4400	Furusmyg fals vit -9,5x35	1 st
	2110	18x120x2400	Furusmyg fals vit -9,5x35	1 st
	2111	18x120x4400	Furusmyg fals vit -9,5x35	1 st
	3111	18x120x4400	Furusmyg fals 0500-N	1 st
	2112	18x145x2400	Furusmyg fals vit -9,5x35	1 st
	2113	18x145x4400	Furusmyg fals vit -9,5x35	1 st
	3113	18x145x4400	Furusmyg fals 0500-N	1 st
	2114	18x170x2400	Furusmyg fals vit -9,5x35	1 st
	2115	18x170x4400	Furusmyg fals vit -9,5x35	1 st
	3115	18x170x4400	Furusmyg fals 0500-N	1 st
	2116	18x195x2400	Furusmyg fals vit -9,5x35	1 st
	2117	18x195x4400	Furusmyg fals vit -9,5x35	1 st
	3117	18x195x4400	Furusmyg fals 0500-N	1 st
	2118	18x220x4400	Furusmyg fals vit -9,5x35	1 st
	2120	18x250x2400	Furusmyg fals vit -9,5x60	1 st

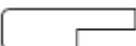
Falsad fönstersmyg Furu	Dimension mm	Beskrivning	Enhet/bunt	Enhet
	2121	18x250x4400	Furusmyg fals vit -9,5x60	1 st
	2123	18x300x4400	Furusmyg fals vit -9,5x60	1 st
	2124	18x350x2400	Furusmyg fals vit -9,5x60	1 st
	2125	18x350x4400	Furusmyg fals vit -9,5x60	1 st

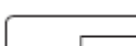

Spårad fönstersmyg MDF	Dimension mm	Beskrivning	Enhet/bunt	Enhet
	1101	16x75x2440	Smyg, spårad MDF	3 st
	1102	16x75x4200	Smyg, spårad MDF	3 st
	110200	16x75x4200	Smyg, spårad MDF 0500	3 st
	1103	16x100x2440	Smyg, spårad MDF	3 st
	1104	16x100x4200	Smyg, spårad MDF	3 st
	110400	16x100x4200	Smyg, spårad MDF 0500	3 st
	1105	16x125x2440	Smyg, spårad MDF	3 st
	1106	16x125x4200	Smyg, spårad MDF	3 st
	110600	16x125x4200	Smyg, spårad MDF 0500	3 st
	1107	16x150x2440	Smyg, spårad MDF	2 st
	1108	16x150x4200	Smyg, spårad MDF	2 st
	110800	16x150x4200	Smyg, spårad MDF 0500	3 st
	1109	16x175x2440	Smyg, spårad MDF	2 st
	1110	16x175x4200	Smyg, spårad MDF	2 st
	111000	16x175x4200	Smyg, spårad MDF 0500	3 st
	1111	16x200x2440	Smyg, spårad MDF	2 st
1112	16x200x4200	Smyg, spårad MDF	2 st	
111200	16x200x4200	Smyg, spårad MDF 0500	2 st	
1113	16x250x2440	Smyg, spårad MDF	2 st	
1114	16x250x4200	Smyg, spårad MDF	2 st	
111400	16x250x4200	Smyg, spårad MDF 0500	2 st	
1115	16x300x2440	Smyg, spårad MDF	2 st	
1116	16x300x4200	Smyg, spårad MDF	2 st	

Falsad fönstersmyg MDF	Dimension mm	Beskrivning	Enhet/bunt	Enhet
	1118	16x50x4200	Smyg, falsad MDF - 9,5x25	3 st
	1119	16x60x4200	Smyg, falsad MDF - 9,5x25	3 st
	1120	16x75x2440	Smyg, falsad MDF - 9,5x25	3 st
	1121	16x75x4200	Smyg, falsad MDF - 9,5x25	3 st
	1122	16x100x2440	Smyg, falsad MDF - 9,5x35	3 st
	1123	16x100x4200	Smyg, falsad MDF - 9,5x35	3 st
	112300	16x100x4200	Fönstersmyg fals 0500-N	3 st
	1124	16x125x2440	Smyg, falsad MDF - 9,5x35	3 st
	1125	16x125x4200	Smyg, falsad MDF - 9,5x35	3 st
	1126	16x150x2440	Smyg, falsad MDF - 9,5x35	2 st
	1127	16x150x4200	Smyg, falsad MDF - 9,5x35	2 st
	112700	16x150x4200	Fönstersmyg fals 0500-N	2 st
	1128	16x175x2440	Smyg, falsad MDF - 9,5x35	2 st
	1129	16x175x4200	Smyg, falsad MDF - 9,5x35	2 st
	1130	16x200x2440	Smyg, falsad MDF - 9,5x35	2 st
	1131	16x200x4200	Smyg, falsad MDF - 9,5x35	2 st
113100	16x200x4200	Fönstersmyg fals 0500-N	2 st	
1132	16x250x2440	Smyg, falsad MDF - 9,5x60	2 st	
1133	16x250x4200	Smyg, falsad MDF - 9,5x60	2 st	

Dörromfattning MDF	Dimension mm	Beskrivning	Enhet/bunt	Enhet
	1001	16x80x2440	Omfattning, 4 rk MDF	3 st
	100100	16x80x2440	Omfattning, 4 rk MDF 0500	3 st
	1002	16x80x4200	Omfattning, 4 rk MDF	3 st
	1003	16x95x2440	Omfattning, 4 rk MDF	3 st
	100300	16x95x2440	Omfattning, 4 rk MDF 0500	3 st
	1004	16x95x4200	Omfattning, 4 rk MDF	3 st
	1005	16x105x2440	Omfattning, 4 rk MDF	3 st
	100500	16x105x2440	Omfattning, 4 rk MDF 0500	3 st
	1006	16x105x4200	Omfattning, 4 rk MDF	3 st
	1007	16x120x2440	Omfattning, 4 rk MDF	3 st
	100700	16x120x2440	Omfattning, 4 rk MDF 0500	3 st
	1008	16x120x4200	Omfattning, 4 rk MDF	3 st
	1009	16x130x2440	Omfattning, 4 rk MDF	3 st
	100900	16x130x2440	Omfattning, 4 rk MDF 0500	3 st
	1010	16x130x4200	Omfattning, 4 rk MDF	3 st
	1011	16x145x2440	Omfattning, 4 rk MDF	3 st
	101100	16x145x2440	Omfattning, 4 rk MDF 0500	3 st
	1012	16x145x4200	Omfattning, 4 rk MDF	3 st
	1013	16x155x2440	Omfattning, 4 rk MDF	2 st
	101300	16x155x2440	Omfattning, 4 rk MDF 0500	2 st
	1014	16x155x4200	Omfattning, 4 rk MDF	2 st
	1015	16x170x2440	Omfattning, 4 rk MDF	2 st
	1016	16x170x4200	Omfattning, 4 rk MDF	2 st
	1017	16x200x2440	Omfattning, 4 rk MDF	2 st
	101700	16x200x2440	Omfattning, 4 rk MDF 0500	2 st
	1018	16x200x4200	Omfattning, 4 rk MDF	2 st

U-list	Dimension mm	Beskrivning	Enhet/bunt	Enhet
	247044	21x27x4400	U-list Furu vit	10 st
	347044	21x27x4400	U-list Furu 0500-N	10 st

SimSALabim-listen	Dimension mm	Beskrivning	Enhet/bunt	Enhet
	8030	18,9x23,2x4200	SimSALabimlist	8 st
	8031	18,9x23,2x2500	SimSALabimlist	8 st
	8035	70x70	Montagehörn SimSALabim	4 st

Clips/ Bättringsfärg	Dimension mm	Beskrivning	Enhet/bunt	Enhet
	8010	Se monterings- anvisning sid 17	Dorn för metallclips	1 st
	8011		Metallclips	400st/frp Frp
	8013		Metallclips	50st/frp Frp
	8015		Metallclips Skruv 1,25x40mm	250st/frp Frp
	8020		Bättringsfärg S 0502-Y	1 st
	8025		Bättringsfärg S 0500-N	1 st

	Planhyvlat	Dimension mm	Beskrivning	Enhet/bunt	Enhet
	5801	8x21	Planhyvlat furu	36	lpm
	5800	8x27	Planhyvlat furu	36	lpm
	5802	8x33	Planhyvlat furu	36	lpm
	5803	8x43	Planhyvlat furu	36	lpm
	5804	8x69	Planhyvlat furu	36	lpm
	4804	8x70	Planhyvlat Ek	35	lpm
	480412	8x70x1200	Planhyvlat Ek	10	st
	5805	8x95	Planhyvlat furu	36	lpm
	4805	8x95	Planhyvlat Ek	35	lpm
	4806	8x120	Planhyvlat Ek	35	lpm
	5807	12x21	Planhyvlat furu	36	lpm
	5838	12x33	Planhyvlat furu	22	lpm
	5839	12x44	Planhyvlat furu	22	lpm
	5808	15x15	Planhyvlat furu	36	lpm
	5809	15x21	Planhyvlat furu	22	lpm
	281044	15x27x4400	Planhyvlat furu vit	10	st
	5810	15x27	Planhyvlat furu	22	lpm
	5811	15x33	Planhyvlat furu	22	lpm
	5812	15x43	Planhyvlat furu	18	lpm
	4812	15x44	Planhyvlat Ek	50	lpm
	281344	15x69x4400	Planhyvlat furu vit	10	st
	5813	15x69	Planhyvlat furu	18	lpm
	4813	15x70	Planhyvlat Ek	25	lpm
	5814	15x95	Planhyvlat furu	18	lpm
	4814	15x95	Planhyvlat Ek	25	lpm
	5815	15x118	Planhyvlat furu	18	lpm
	4815	15x120	Planhyvlat Ek	25	lpm
	5816	15x143	Planhyvlat furu	14	lpm
	4816	15x145	Planhyvlat Ek	25	lpm
	5817	21x21	Planhyvlat furu	22	lpm
	4817	21x21	Planhyvlat Ek	35	lpm
	5818	21x27	Planhyvlat furu	22	lpm
	5819	21x33	Planhyvlat furu	14	lpm
	4819	21x33	Planhyvlat Ek	35	lpm
	282044	21x43x4400	Planhyvlat furu vit	10	st
	5820	21x43	Planhyvlat furu	14	lpm
	4820	21x44	Planhyvlat Ek	25	lpm
	5836	21x56	Planhyvlat furu	14	lpm
	5821	21x69	Planhyvlat furu	14	lpm
	4821	21x70	Planhyvlat Ek	15	lpm
	5822	21x95	Planhyvlat furu	14	lpm
	4822	21x95	Planhyvlat Ek	15	lpm
	5823	21x118	Planhyvlat furu	14	lpm
	4823	21x120	Planhyvlat Ek	10	lpm
	5824	21x143	Planhyvlat furu	14	lpm
	4824	21x145	Planhyvlat Ek	10	lpm
	5825	21x165	Planhyvlat furu	14	lpm
	5841	21x185	Planhyvlat furu	14	lpm
	4826	21x200	Planhyvlat Ek	10	lpm
	5827	27x27	Planhyvlat furu	14	lpm
	5828	27x69	Planhyvlat furu	14	lpm

Planhyvlat, forts.	Dimension mm	Beskrivning	Enhet/bunt	Enhet
	5840 27x95	Planhyvlat furu	15	lpm
	4829 27x95	Planhyvlat Ek	15	lpm
	5829 27x118	Planhyvlat furu	14	lpm
	5830 33x33	Planhyvlat furu	11	lpm
	5837 33x43	Planhyvlat furu	11	lpm
	5831 33x69	Planhyvlat furu	11	lpm
	5832 33x95	Planhyvlat furu	11	lpm
	5833 33x118	Planhyvlat furu	11	lpm
	5834 33x143	Planhyvlat furu	11	lpm
	5835 44x44	Planhyvlat furu	11	lpm
	921B 69x69	Planhyvlat furu B 4rk	11	lpm

Kortlister	Dimension mm	Enhet/bunt	Enhet/bunt	Enhet
8576894	12x43x1000	Foder Furu vit	10	st
8576895	12x56x1000	Foder Furu vit	10	st
8576896	12x69x1000	Foder Furu vit	10	st
8738669	8x1000	Rundstav obeh	20	st
8576933	10x1000	Rundstav obeh	20	st
8738668	15x1000	Rundstav obeh	20	st
8576934	21x1000	Rundstav obeh	20	st
8576955	25x1000	Rundstav obeh	20	st
8576935	27x1000	Rundstav obeh	20	st
8576936	33x1000	Rundstav obeh	20	st
8576937	12x12x1000	Kvartstav obeh	20	st
8576938	15x15x1000	Kvartstav obeh	20	st
8576939	21x21x1000	Kvartstav obeh	20	st
8576948	12x12x1000	Kvartstav vit	20	st
8576949	15x15x1000	Kvartstav vit	20	st
8738664	21x21x1000	Kvartstav vit	20	st
444212	12x12x1200	Kvartstav Ek lackad	35	st
8576940	8x21x1000	Foglist obeh	15	st
8576941	8x27x1000	Foglist obeh	15	st
8576942	8x33x1000	Foglist obeh	15	st
8576953	8x43x1000	Foglist obeh	15	st
8738661	8x21x1000	Foglist vit	15	st
8738662	8x27x1000	Foglist vit	15	st
8576956	8x33x1000	Foglist vit	15	st
8738663	8x43x1000	Foglist vit	15	st
8576943	8x15x1000	Smyglist Obeh	15	st
8576944	8x21x1000	Smyglist Obeh	15	st
8576945	8x27x1000	Smyglist Obeh	15	st
8576957	8x15x1000	Smyglist vit	15	st
8576958	8x21x1000	Smyglist vit	15	st
8738670	8x27x1000	Smyglist vit	15	st
441012	8x15x1200	Smyglist Ek lackad	35	st
441212	8x27x1200	Smyglist Ek lackad	35	st
8580112	21x21x1000	Hörnlist obeh	10	st
8580113	27x27x1000	Hörnlist obeh	10	st
8576974	21x21x1000	Hörnlist vit	10	st
8576975	27x27x1000	Hörnlist vit	10	st

Kortlister, forts.	Dimension mm	Enhet/bunt	Enhet/bunt	Enhet
8576959	8x15x1000	Planhyvlad furu	15	st
8738667	8x43x1000	Planhyvlad furu	10	st
8576969	8x69x1000	Planhyvlad furu	10	st
8576965	8x95x1000	Planhyvlad furu	10	st
8738665	12x12x1000	Planhyvlad furu	10	st
8576968	12x33x1000	Planhyvlad furu	10	st
8576970	15x15x1000	Planhyvlad furu	10	st
8576960	15x27x1000	Planhyvlad furu	6	st
8738666	15x33x1000	Planhyvlad furu	6	st
8576961	15x43x1000	Planhyvlad furu	5	st
8576962	21x21x1000	Planhyvlad furu	6	st
8576963	21x33x1000	Planhyvlad furu	4	st
8576964	21x43x1000	Planhyvlad furu	4	st
8576971	21x69x1000	Planhyvlad furu	4	st
8576972	21x95x1000	Planhyvlad furu	4	st
480512	8x95x1200	Planhyvlad Ek	10	st
481312	15x70x1200	Planhyvlad Ek	6	st
481412	15x95x1200	Planhyvlad Ek	6	st
482112	21x70x1200	Planhyvlad Ek	4	st
482212	21x95x1200	Planhyvlad Ek	4	st



Lister MDF	Dimension mm	Beskrivning	Enhet/bunt	Enhet
1301	12x43x2200	Foder vit MDF	10	st
1302	12x43x4200	Foder vit MDF	10	st
1303	12x56x2200	Foder vit MDF	10	st
1304	12x56x4200	Foder vit MDF	10	st
1305	12x69x2200	Foder vit MDF	10	st
1306	12x69x4200	Foder vit MDF	10	st
1307	12x95x2440	Foder vit MDF	10	st
1308	12x95x4200	Foder vit MDF	10	st
1401	12x69x2200	Allmogefoder vit MDF	5	st
1402	12x69x4200	Allmogefoder vit MDF	5	st
1404	12x95x4200	Allmogefoder vit MDF	5	st
1405	16x69x2200	Allmogefoder vit MDF	5	st
1406	16x69x4200	Allmogefoder vit MDF	5	st
1407	16x95x2440	Allmogefoder vit MDF	5	st
1408	16x95x4200	Allmogefoder vit MDF	5	st
1351	12x43x4200	Sockel vit MDF	10	st
1352	12x56x4200	Sockel vit MDF	10	st
1353	12x69x4200	Sockel vit MDF	10	st
1453	16x69x4200	Allmogesockel vit MDF	5	st
1454	16x95x4200	Allmogesockel vit MDF	5	st
1713	15x56x4200	Allmogetaklist vit MDF	5	st
1732	15x56x4200	Hålkälslist vit MDF	5	st

Bastuartiklar	Dimension mm	Beskrivning	Enhet/bunt	Enhet
 7910	12x68	Bastupanel Asp	10st/bunt	lpm
 7920	21x65	Bastulav Asp	10st/bunt	lpm
 790524	12x42x2400	Bastufoder Asp	10	st

Halvstav	Dimension mm	Beskrivning	Enhet/bunt	Enhet
547825	33x2500	Halvstav obh	10	st

Lustejp	Beskrivning	Enhet/bunt	Enhet
8050	Lustejp 20 mm, 100m/rulle	100m	Rulle
8055	12x56x3000 Sockel med lustejp Furu 0500-N	10	st
8056	12x56x3000 Sockel med lustejp Furu vit	10	st

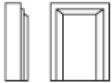
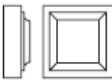
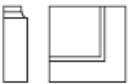
Dekorlist	Dimension mm	Beskrivning	Enhet/bunt	Enhet
 570124	8,5x22x2400	Dekorlist furu obeh	10	st
570224	12x34x2400	Dekorlist furu obeh	10	st

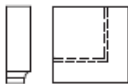
Klossar	Dimension m	Beskrivning	Enhet/bunt	Enhet
 27510028	75x100x28	Bottenkloss vit	2	fp
57510028	75x100x28	Bottenkloss obh	2	fp
210015528	100x155x28	Bottenkloss vit	2	fp
510015528	100x155x28	Bottenkloss obh	2	fp
 2757528	75x75x28	Toppkloss vit	2	fp
5757528	75x75x28	Toppkloss obh	2	fp
210010028	100x100x28	Toppkloss vit	2	fp
510010028	100x100x28	Toppkloss obh	2	fp
 23030100	30x30x100	Sockelkloss innehörn vit	2	fp
53030100	30x30x100	Sockelkloss innehörn obh	2	fp
23030155	30x30x155	Sockelkloss innehörn vit	2	fp
53030155	30x30x155	Sockelkloss innehörn obh	2	fp
 24040155	40x40x155	Sockelkloss ytterhörn vit	2	fp
54040155	40x40x155	Sockelkloss ytterhörn obh	2	fp
52076300	20x76x300	Sockelkloss Skrea obh	2	fp
520102300	20x102x300	Sockelkloss Skrea obh	2	fp
525125300	25x125x300	Sockelkloss Skrea obh	2	fp
 2353570	35x35x70	Takkloss innehörn vit	2	fp
5353570	35x35x70	Takkloss innehörn obh	2	fp
2505090	50x50x90	Takkloss innehörn vit	2	fp
5505090	50x50x90	Takkloss innehörn obh	2	fp

Diverse	Dimension mm	Beskrivning	Enhet/bunt	Enhet
43906713	2x25x2000	Skarvlist Aluminium	8	st
43906762	3x30x2000	Skarvlist Aluminium	8	st
43906758	40x15x2000	Trappnos Aluminium	8	st
43906781	15x15x2000	Vinkelprofil Aluminium	8	st
43906796	20x20x2000	Vinkelprofil Aluminium	8	st
43906815	30x30x2000	Vinkelprofil Aluminium	8	st
43906853	15x15x2000	Fyrkantsrör Aluminium	8	st
43906864	20x20x2000	Fyrkantsrör Aluminium	8	st
43906940	6x2000	Armeringsjärn Galv	8	st
43906955	8x2000	Armeringsjärn Galv	8	st
43906966	10x2000	Armeringsjärn Galv	8	st
43907076	25x25x2000	Vinkelprofil Järn Galv	8	st
43907080	38x38x2000	Vinkelprofil Järn Galv	8	st
43907125	15x15x2600	Hörnlist Pvc Vit	20	st
43907133	20x20x2600	Hörnlist Pvc Vit	20	st
43907144	25x25x2600	Hörnlist Pvc Vit	20	st
43907152	30x30x2600	Hörnlist Pvc Vit	20	st
43907163	35x35x2600	Hörnlist Pvc Vit	20	st
43907178	50x50x2600	Hörnlist Pvc Vit	20	st
43907235	18x21x2600	U-Profil Pvc Vit	10	st
43907265	13x24x2600	Sockellist Pvc Vit	10	st
43907292	2x20x2600	Täcklist Pvc Vit	20	st
43907303	2x30x2600	Täcklist Pvc Vit	20	st
43907318	15x15x2600	Hörnlist Pvc Svart	20	st
43907322	20x20x2600	Hörnlist Pvc Svart	20	st
43907337	25x25x2600	Hörnlist Pvc Svart	20	st
45232978	15x15x2600	Hörnlist Pvc Ekprofil	20	st
45232982	20x20x2600	Hörnlist Pvc Ekprofil	20	st
45233065	10x2000	Rör Aluminium	8	st
45233073	16x2000	Rör Aluminium	8	st
47504618	15x15x2000	Vinkelprofil Aluminium Lack	8	st
47504622	20x20x2000	Vinkelprofil Aluminium Lack	8	st
47504637	20x15x2000	Vinkelprofil Aluminium Lack	8	st

Övrigt	Beskrivning	Enhet/bunt	Enhet
9001	Broschyr, sortimentslista	1	st



MONTERINGSANVISNING

Med metallclips

Art.nr: 8011

Art.nr Dom: 8010

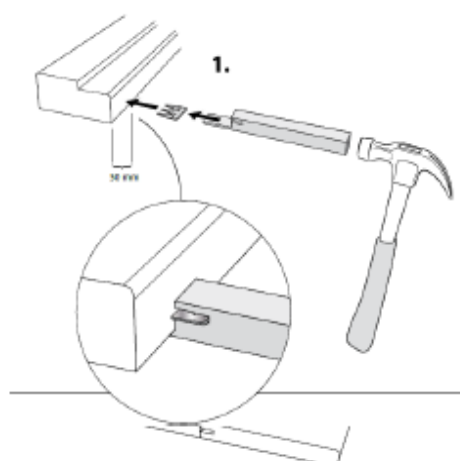

U-list furu vit

Art.nr: 2470

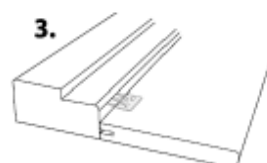
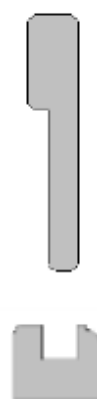



Produktinformation Vitmålad Furu

Byggnadslister i vitmålad furu, NCS S 0502-Y/S 0500-N, så som foder, sockel, taklister, smålister etc. Lagervaror BASTA registrerade, BVB bedömda och Fsc-certifierade.

Emissionstestade hos RISE 2017 som ligger till grund för vissa bedömningar ovan.

Råvara

Fingerskarvad sågad furu alternativt sågad furu i fallande längd.

Färg

Grundmålade med vattenbaserad färg och toppmålad med vattenbaserad färg från Teknos. Glans 25-30.

Emballage

Produkterna är förpackade med sträckfilm och bandade med plastband alternativt stålband. Producenten är ansluten till fti (fd REPA) eller Estniska motsvarigheten i Estland, ERO. Detta gör att förbrukade emballageprodukter kan lämnas in på återvinningscentraler.

Övrigt

Rengöring - använd ett mildt rengöringsmedel och lätt fuktad trasa. Övermålningsbar - rugga upp ytan med sandpapper 220-240 för bättre vidhäftning. Applicera därefter ny färg. Följ alltid anvisningarna från respektive färgleverantör.



Produktinformation MDF

Byggnadslister i MDF så som smygar, omfattningar, foder, sockel etc.

Råvara

MDF (Medium Density Fiberboard). All inköpt MDF motsvarar kraven för E-1 (dvs. den uppfyller kraven för formaldehydavgivning).

Färg

Ytbehandlade med endast vattenbaserade färger. Alla produkter är grundade tre gånger med vattenbaserad grund och toppad med en vatten-UV. Kulör = NCS S 0502-Y/NCS S 0500-N

Emballage

Produkterna är förpackade med sträckfilm och bandade med plastband. Producenten är ansluten till REPA. Detta gör att förbrukade emballageprodukter kan lämnas in på återvinningscentraler.

Övrigt

Rengöring - använd ett mildt rengöringsmedel och lätt fuktad trasa.

Övermålningsbar - rugga försiktigt upp ytan för bättre vidhäftning och applicera ny färg